

# PANTHELLA 250 TABLE LAMP

The fixture emits a glare-free, soft and comfortable illumination. The metal shade versions direct the light directly downwards and create a pleasant illumination due to the inner white painted shade and the reflection from the trumpet-shaped stem. The opal acrylic produces a diffused comfortable light due to the translucent shade, the downward reflection from the inner shade and the reflection from the trumpet-shaped stem.

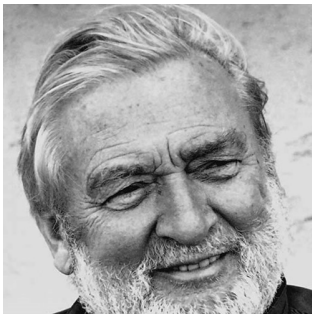

## Verner Panton

Verner Panton (1926-1998) is famous for his inspirational and colorful personality. A unique person with a special sense for color, shape, light function and space. Over the course of his career, Panton introduced a series of modern lamps with personalities unlike any of his Scandinavian contemporaries.



Set location -  
The Quest



## Product info

### Information

White cord on white opal, white metal, brass metallised and Pale Rose versions. Black cord on all other versions. LED driver fitted externally on cord. Turn on/off the light with light fading in/out. Stepless dim of the light to a suitable level between 15 and 100%. Timer function to automatically turn off the light after an amount of time, selectable between off/4 hours/8 hours. Function to set a fixed light level each time the lamp is connected to main power. This product is fitted with an integrated energy-saving LED light source. Should you wish to replace it, please contact Louis Poulsen so we can help you purchase the correct LED Replacement Kit. Please note that LED-replacement should always be carried out by an authorised electrician.

### Mounting

Plastic cord. Cable length: 2.5m. LED-driver: Separate, plugs into power outlet. Light control: In-line switch. Timer function: 4 hours/8 hours. Stepless dimming between 15 and 100%.

### Finish

White opal acrylic shade with white stand. Grey opal acrylic shade with high lustre chrome stand. High lustre chrome shade and stand. Brass metallised shade and stand. Pale Rose, Pale Blue, Coral, White, Black or Orange, powder coated, shade and stand.

### Materials

Shade: Injection moulded acrylic or deep drawn steel. Base and Housing: Die cast aluminium. Diffuser: Injection moulded opal pmma.

### Sizes and weights

Width x Height x Length (mm) | 250 x 335 x 250 Max 1.2 kg

### Class

Ingress protection IP20. Electric shock protection II.

### Light source

LED 2700K 10W

Lumen: 428

Max. diameter: 48 mm

Max. height: 83 mm

### Information

White cord on white opal, white metal, brass metallised and Pale Rose versions. Black cord on all other versions. LED driver fitted externally on cord. Turn on/off the light with light fading in/out. Stepless dim of the light to a suitable level between 15 and 100%. Timer function to automatically turn off the light after an amount of time, selectable between off/4 hours/8 hours. Function to set a fixed light level each time the lamp is connected to main power. This product is fitted with an integrated energy-saving LED light source. Should you wish to replace it, please contact Louis Poulsen so we can help you purchase the correct LED Replacement Kit. Please note that LED-replacement should always be carried out by an authorised electrician.



## Related products



Panthella 400 Table Lamp



Panthella Floor

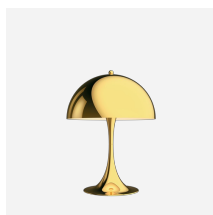

Panthella 320 Table Lamp

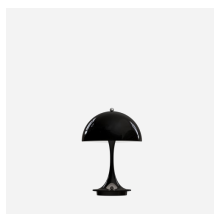

Panthella Portable Metal

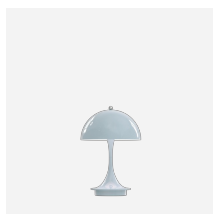

Panthella 160 Portable

## Product variants

Colour	Cable type	Light source	Lumen
<input checked="" type="radio"/> Black	Blk pl	LED 2700K 10W	428
<input type="radio"/> Brass metallised	Wht pl		460
<input type="radio"/> Coral			589
<input type="radio"/> Grey opal acryl			
<input type="radio"/> High lustre chrome plated			
<input type="radio"/> Orange			
<input type="radio"/> Pale blue			
<input type="radio"/> Pale rose			
<input type="radio"/> White			
<input type="radio"/> White opal acryl			

## Design

Verner Panton

## Weight

Min: 1.18 kg Max: 1.18 kg

## Finish

Black, Brass metallised, Coral, Grey opal acryl, High lustre chrome plated, Orange, Pale blue, Pale rose, White, White opal acryl

# Light distribution diagrams

### Cartesian

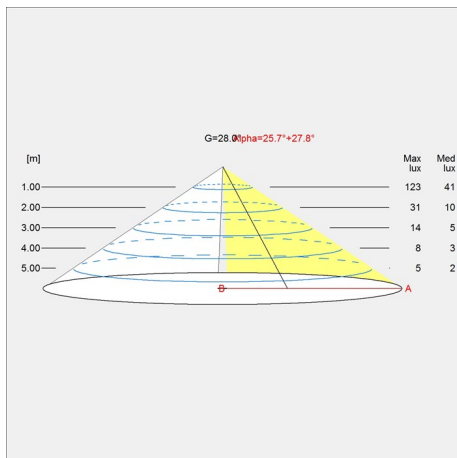

### Isolux

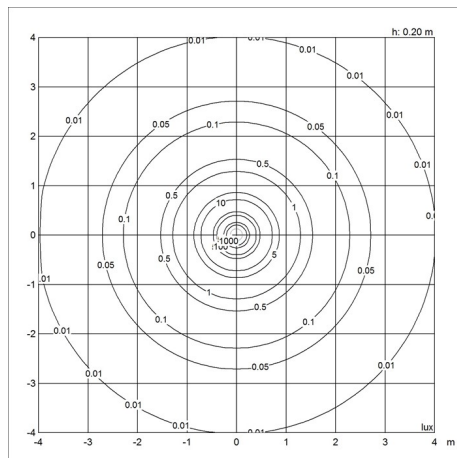

### Polar

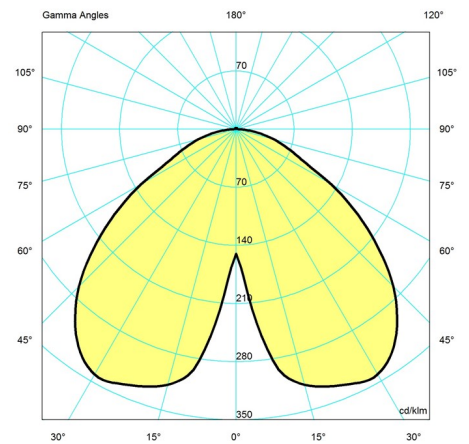

## Spare parts & accessories

## Panthella 250 Table Lamp

Product	Variant number
Adaptor 12V black	5744164867
Adaptor 12V white	5744164870
Panthella MINI top nut	5744166234
Panthella MINI Yellow/Green shade	5744166247
Panthella MINI White shade	5744166250
Panthella MINI Black shade	5744166263
Panthella MINI Blue/Green shade	5744166276
Panthella MINI Pink shade	5744166289
Panthella MINI Blue shade	5744166292
Panthella MINI Red shade	5744166302
Panthella MINI Yellow shade	5744166315
Panthella MINI Orange shade	5744166328
Panthella MINI Violet shade	5744166331
Panthella MINI Opal shade	5744166344
Panthella MINI Chrome shade	5744162568
Panthella MINI diffuser	5744161828
Panthella MINI shade brass PVD	5744167589
Panthella MINI top nut brass PVD	5744167660
Panthella MINI Opal Grey shade	5744168054
Panthella MINI shade pale blue	5744612704
Panthella MINI Coral shade	5744612717
Panthella MINI Pale Rose shade	5744902087
Panthella MINI white cord	5744168436
Panthella MINI black cord	5744168533